

Article number: 588N3B116ST0411

Description: Solenoid valve type N3B116.ST0.411 3/2 NC
24 VAC 50HZ orifice 1,6 housing in Stainless AISI 303 Inlet port G1/8"

Measures

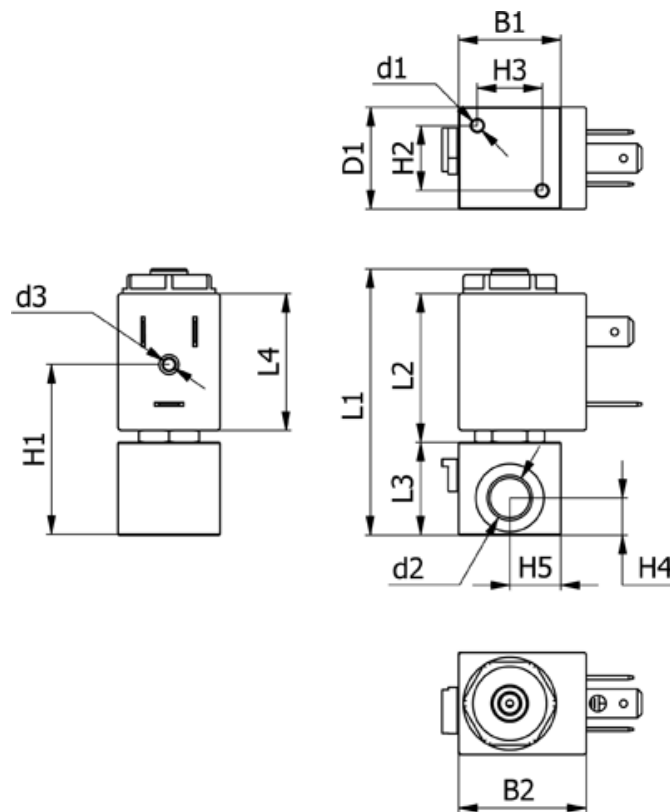

| | | |
|------------|-----------|-------------------------|
| B1 = 22 | H2 = 14 | Orifice = 1.6 |
| B2 = 31.1 | H3 = 14 | Valve function = 3/2 NC |
| d1 = M3x6 | H4 = 8 | Voltage = 24 VAC 50HZ |
| D1 = 22 | H5 = 11 | |
| d2 = G1/8" | L1 = 56.2 | |
| d3 = M3x4 | L2 = 32.1 | |
| Flow = 1.1 | L3 = 20 | |
| H1 = 36.6 | L4 = 29.5 | |